



## **LCD SCOPE 292WVA**

### **MULTI-FORMAT HD & SD WAVEFORM VECTOR AND AUDIO MONITOR**

### **OPERATOR'S HANDBOOK**

### **ISSUE B1**

© 2007 Hamlet Video International Ltd. All rights reserved

This handbook contains proprietary information of Hamlet Video International Limited and may not be copied in whole or in part nor its contents disclosed to any third parties without the express written consent of the company.

Hamlet Video International Limited.

Maple House, 11 Corinium Business Centre, Raans Road, Amersham, Bucks HP6 6FB England.  
Main Line: +44 (0)1494 729 728, Fax Line: +44 (0)1494 723 237, Free phone (UK): 0500 625 525  
E-mail: [sales@hamlet.co.uk](mailto:sales@hamlet.co.uk) Web site: [www.hamlet.co.uk](http://www.hamlet.co.uk)

Hamlet Video International USA service center , Tecads Inc, 23 Del Padre St, Foothill Ranch, CA 92610, U.S.A.  
Tel: +1 (949) 597 1053, Fax: +1 (949) 597 1094. Toll Free Tel number: (866) 4 HAMLET  
E-mail: [service@hamlet.us.com](mailto:service@hamlet.us.com) Web site: [www.hamlet.us.com](http://www.hamlet.us.com)

IN CORRESPONDENCE CONCERNING THIS INSTRUMENT  
PLEASE QUOTE THE SERIAL NUMBER PRINTED ON THE  
LABEL AT THE REAR OF THE UNIT



## CONTENTS

### GENERAL INFORMATION

List of figures	4
Warranty	5
Safety and EMC compliance	6
Product disposal instructions	6
Overview	7
Front view	8
Rear view	9

### OPERATING INSTRUCTIONS

Installation	10
Getting Started	11
Select the source of the video signal	12
Select the source of the sync reference	13

#### Video waveform measurements:

To use the video timebase ranges	13
To use the parade function	13
To measure video 'out of gamut' levels	14
To change the video gain	14
Bowtie display	14

#### Video vector measurements:

To change the vector gain	14
---------------------------	----

#### Display adjustments:

To change the displayed video	14
To change the display persistence	14
Video filter	14

#### Remote control:

List of key commands	15
List of rotary commands	15

#### Additional functions:

To start the unit in known state	16
To store and recall settings	16

Power Source	16
--------------	----

Battery Charging	16
------------------	----

## CONTENTS

<b>Audio option:</b>		
To select the audio source	.....	17
To select audio scales	.....	17
To display audio vectors	.....	17
Audio output	.....	17
<b>CALIBRATION</b>	.....	18
<b>TECHNICAL SPECIFICATION</b>	.....	19
Troubleshooting	.....	21
Analog Basics	.....	22
Serial Digital Basics	.....	26
HD Serial Digital Basics	.....	31
Useful Websites	.....	36
Contact details and customer support	.....	36

## FIGURES

Fig 1 Front View	.....	8
Fig 2 Rear View	.....	9
Fig 3 Getting Started	.....	11
Fig 4 Getting Started - Screen	.....	11
Fig 5 Digital Error Display	.....	16
Fig 6 Audio Switch	.....	17
Fig 7 Audio Scales	.....	17
Fig 8 PAL Basics	.....	23
Fig 9 NTSC Basics	.....	24
Fig 10 Serial Digital Basics	.....	29
Fig 11 625 Field Blanking	.....	30
Fig 12 525 Field Blanking	.....	30
Fig 13 HD Sample structure	.....	32
Fig 14 HD Embedded audio	.....	34

## GENERAL INFORMATION

### WARRANTY

This product is manufactured by Hamlet Video International Ltd and is warranted to be free from defects in components and factory workmanship under normal use and service for a period of one year from the date of purchase.

### FREE EXTENDED WARRANTY

The warranty period can be extended to two years by registering the instrument on the Hamlet web site

<http://www.hamlet.co.uk/serv.html>

### TERMS AND CONDITIONS

During the warranty period, Hamlet Video International Ltd will undertake to repair or at its option, replace this product at no charge to its owner when failing to perform as specified, provided the unit is returned shipping prepaid, to the factory or authorised service facility.

No other warranty is expressed or implied. Warranty shall not be applicable and be void when this product is subjected to:

1. Repair work or alteration by persons other than those authorised by Hamlet Video International Ltd in such a manner as to injure the performance, stability, reliability or safety of this product.
2. Misuse, negligence, accident, act of God, war or civil insurrection.
3. Connection, installation, adjustment or use otherwise than in accordance with the instructions in this manual.

Hamlet Video International Ltd reserves the right to alter specifications without notice. This warranty does not affect the statutory rights of the UK customer.

## GENERAL INFORMATION

### SAFETY COMPLIANCE

This product is manufactured and tested to comply with **BS EN 61010-1 : 1993**  
Safety requirements for electrical equipment for measurement, control and laboratory use.



### EMC COMPLIANCE

We: Hamlet Video International Ltd  
Maple House, 11 Corinium Business Centre, Raans Road,  
Amersham, Bucks, HP6 6FB, England.

Declare under our sole responsibility that the product **HAMLET LCD SCOPE 292WVA** to which this declaration relates are in conformity with the following standards:

**EN50081-1** Generic emissions standard for light industrial applications.

**EN50082-1** Generic immunity standard for light industrial applications.

Following the provisions of EU EMC directives 89/336/EEC and 92/31/EEC.

**NOTE.** During the EMC certification of this product, shielded cables were used. We recommend that they be used in operation.

### PRODUCT DISPOSAL INSTRUCTIONS

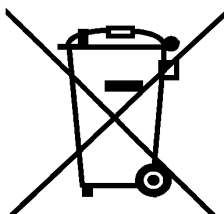

The symbol shown above and on the LCDSCOPE 292WVA means the product is classed as Electrical or Electronic Equipment and should not be disposed with other commercial waste at the end of its working life.

The Waste of Electrical and Electronic Equipment (WEEE) Directive (2002/96/EC) has been put in place to recycle products using best available recovery and recycling techniques to minimise the impact on the environment, treat any hazardous substances and avoid the increasing landfill.

#### **Product disposal instructions for business users.**

Business users should contact their LCDSCOPE 292WVA supplier to arrange for its return to Hamlet, who will safely dispose of it and ensure that this LCDSCOPE 292WVA is not mixed with other commercial waste for disposal.

## OVERVIEW

The Hamlet LCD SCOPE 292WVA is a 3U high half width 19" rack mounting monitor designed to fit into standard rack enclosure.

The unit accepts all major high definition and standard definition serial digital video standards as well as analogue composite (PAL/625 and NTSC/525) video, YC video and component video (YCrCb or RGB). It displays the waveforms on a quarter VGA high contrast liquid crystal display. All the standard displays are produced, including H and V Mag, Line Select, Component Parade, Filter Parade and Bowtie. There is an additional display of RGB gamut from the component or digital inputs and front panel warning lights and alarm for signals above peak white or below black.

Proprietary digital signal processing produces displays with the look of a CRT but without the problems of scan burn, eht difficulties etc. The very low power consumption also allows it to be used in the field from external 12V or its own internal rechargeable batteries.

An additional feature is displays of composite and component vectors. There are also displays of four channels of audio and a vector audio phase display. There is a headphone monitor output jack. The unit also contains an SD/HD audio de-embedder which displays on the audio bar graphs and outputs analog stereo audio to the monitor jack.

There is an analog component (Y, Cr, Cb + sync) video output from the SD or HD serial digital signal.

# FRONT VIEW

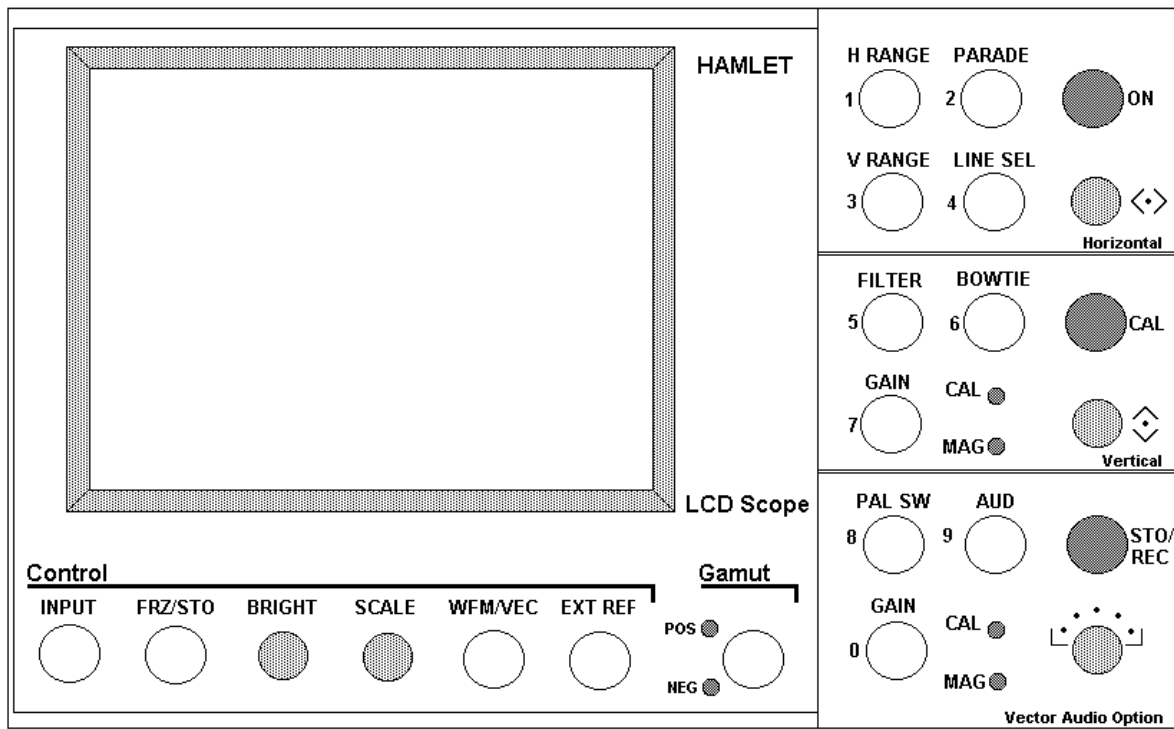

Fig 1

# REAR VIEW

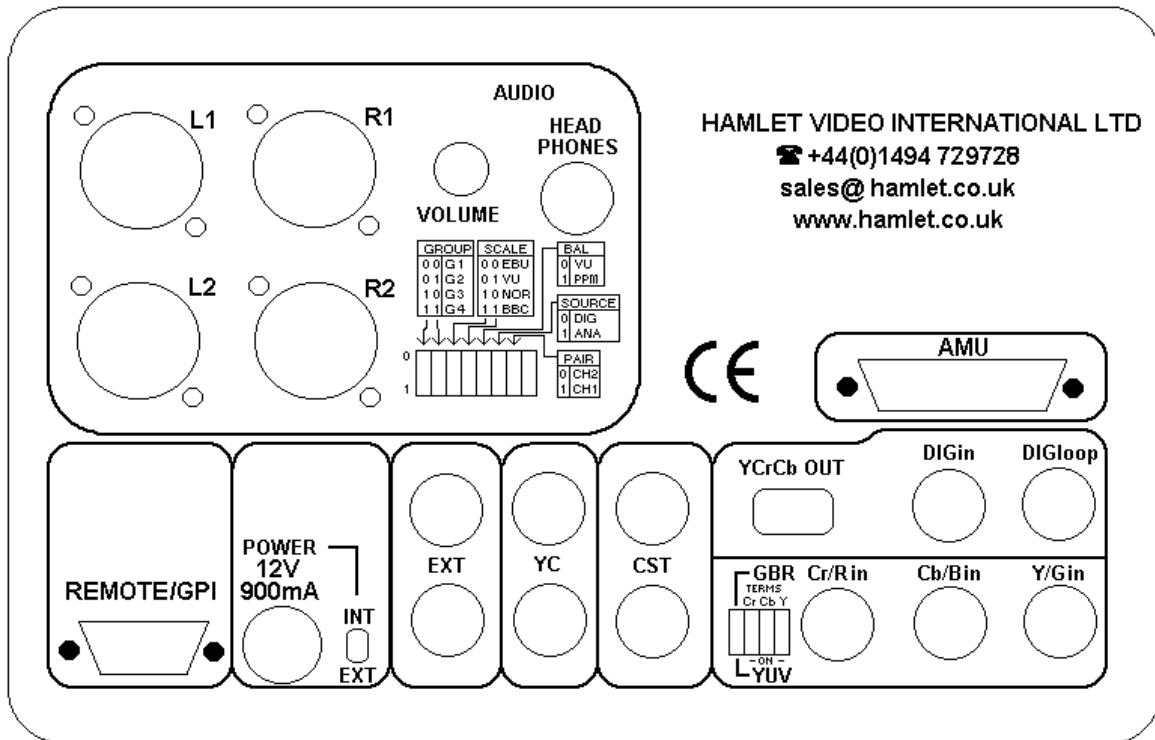

Fig 2

## **INSTALLATION**

### **UNPACKING**

The LCDSCOPE 292WVA is shipped from the factory in a specially constructed packing case. Exercise caution when unpacking the unit to prevent damage to the case finish. Examine the unit carefully for damage which may have occurred during shipment

### **MOUNTING INSTRUCTIONS**

Hamlet can supply rack mount kits to fit the unit into a standard 19 inch equipment rack, where it occupies half the rack width and 3U of height. The unit itself generates little heat and does not need forced ventilation, but heat generated from adjacent units should not cause the case temperature to rise above 50 deg.C.

### **POWER REQUIREMENTS**

The LCDSCOPE 292WVA should be powered from the supplied adaptor or a regulated supply of 12VDC of at least 1 amp rating to 2.1mm power socket.

### **SIGNAL AND CONTROL CONNECTIONS**

Video input and output cable connections are made to BNC sockets on the rear panel, with YC video to 4 pin mini din sockets. All video loops should be terminated with 75 ohms. Audio input is to 3 pin xlr sockets. To utilise all the LCDSCOPE functions, the video inputs, audio inputs and external reference (video or syncs) should all be wired.

### **CHECKOUT FOR INITIAL USE**

After installation as above, switch on the LCDSCOPE and operate each control in turn, verifying correct response as described in the operating instructions.

### **PREVENTATIVE MAINTENANCE**

The Hamlet LCDSCOPE should be visually inspected, cleaned and the calibration checked every one year of operation.

**CAUTION.** The front panel is made from polycarbonate, which may soften if cleaned with some organic solvents. Do not allow water to get inside the equipment case.

## GETTING STARTED

1. Connect the supplied 12V power adaptor output to the rear 2.1mm input jack.
2. Apply AC mains (100 - 250VAC) to the power adaptor.
3. Connect a composite video feed to the rear CST input BNC and apply a 75 ohm terminator to the CST loop bnc.
4. Hold down the front panel INPUT button whilst pressing the ON button, see fig 3. This starts the LCDSCOPE in a pre - programmed state, see fig 4. When the unit is subsequently turned on, it will remember the panel settings used previously.

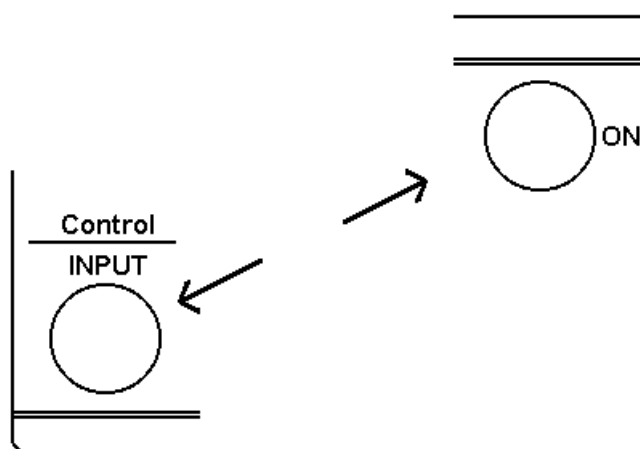

Fig 3

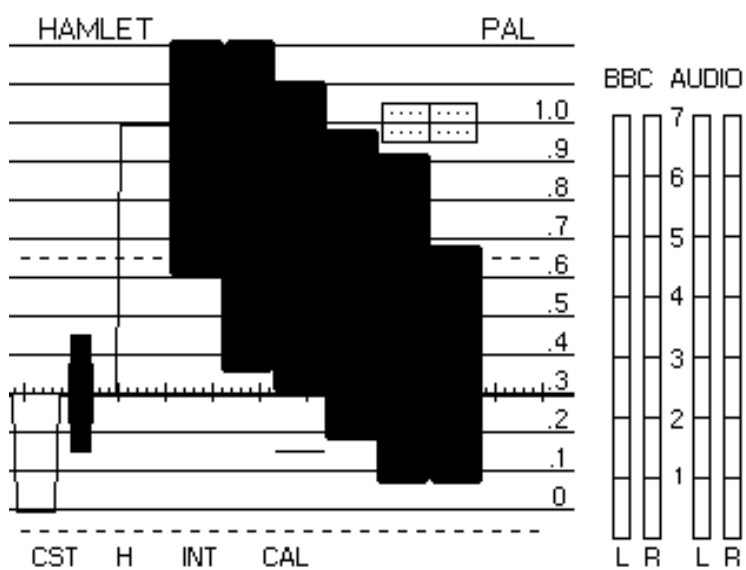

Fig 4

# OPERATING INSTRUCTIONS

## VIDEO INPUT

### Video Source Selection

Pressing the INPUT button toggles between the four input formats and the format is displayed on-screen as CST, YC or CNT. Digital inputs show the standard:

Connect composite signals (PAL or NTSC) to the rear CST BNC. CST loop must be terminated with 75 ohms.

Connect component signals to the Y/Gin, Cb/Bin and Cr/R BNCs. A rear dip switch selects YCrCb or RGB component input formats and input terminations. RGB mode should not be used with an SDI source as this is always in Y,Cb,Cr format.

Connect an SD or HD SDI video signal to the rear DIGin BNC. An active (re-equalised) loop output is available from the rear DIGloop BNC.

### Standard display

60 is HD 1080/60/2:1

726 is HD 720/60/1:1

50 is HD 1080/50/2:1

725 is HD 720/50/1:1

48 is HD 1080/24/sf

30 is HD 1080/30/1:1

25 is HD 1080/25/1:1

PAL is SD 625

24 is HD 1080/24/1:1

NTSC is SD 525

1/1.001 standards show a \* symbol

When in digital input mode, holding down the input button for one second switches the display between the normal status display to a digital error display.

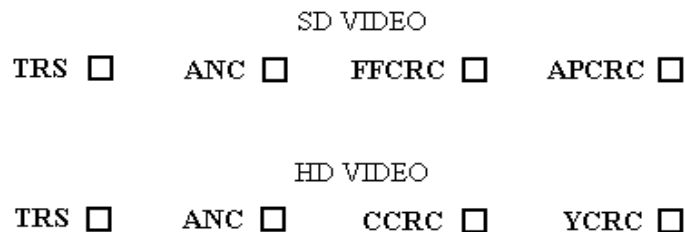

Fig 5

The box is normally blank, but an E is displayed for a second if there is an error.

TRS	Errors in EAV/SAV etc.
ANC	Ancillary packet errors, eg audio faults.
FFCRC	SD Full field CRC errors.
APCRC	SD Active field CRC errors.
YCRC	HD Y stream video errors.
CCRC	HD C stream video errors.

## OPERATING INSTRUCTIONS

### Sync Reference Source Selection

To select which is to be used, press the EXT-REF key, this key toggles between the three options, INTERNAL, EXTERNAL and HFT™ (hands free timing) which alternates between internal and external every second to facilitate syncing two sources. The sync source is displayed on-screen.

The reference signal can be derived from the signal being used (internal) or from an analogue reference of video or sync (external) applied to the rear bnc labelled EXT IN.

EXT loop must be terminated with 75 ohms.

### VIDEO WAVEFORM MEASUREMENTS

#### Video Timebase Ranges

1H, 2H or H magnified are selected by pressing the H RANGE key.

1V or V magnified are selected by pressing the V RANGE key.

#### Waveform Parade

Pressing the PARADE key gives a 3H display of Y,Cr,Cb or RGB from component sources or Flat, Low Pass, Chroma Pass from composite sources.

A new feature of an RGB parade has been added, for Analogue YCrCb inputs or SD/HD serial digital signals if fitted. To switch the unit between the standard YCrCb parade and the new RGB parade, switch on the unit while holding down the PARADE key.

#### Line selection

This mode is selected by pressing LINE SEL and shows two lines. The line number is selected by turning the horizontal shift rotary control. The line and field numbers are displayed on-screen and relate to the left line.

#### To measure video 'Out of Gamut' levels

With a component input, pressing the GAMUT key produces an additional display on the right of the screen. This is a 1H display of R, G, and B superimposed. Two graticule lines indicate the black and peak white levels required for the video to remain within gamut.

The gamut alarm sounder is enabled/disabled by holding down the GAMUT key for more than one second. The letter A is displayed bottom right of the screen when enabled. The key operates when released.

Due to the predominance of 75% colour space, the 525 line gamut screen can be configured to display a Y low pass signal rather than R,G,B.

#### To change the Video Gain

Video gain can be changed from normal (x1) to expanded (x3.33) by pressing the video GAIN key. The current setting is displayed on the front panel CAL and MAG lights.

#### Bowtie display

If a bowtie signal is available, accurate amplitude and timing measurements may be made.

Press the BOWTIE key and set the unit to MAG GAIN mode for optimum resolution.

The BOWTIE key toggles between (Y - U), (Y - V) and Bowtie OFF.

## OPERATING INSTRUCTIONS

### **Composite display from an SD SDI source**

When viewing an SD SDI source, the component video signal can be viewed as a composite waveform by selecting CPASS mode.

### **VIDEO VECTOR MEASUREMENTS**

#### **To change the Vector gain:**

PAL/625 vector gain can be toggled between 75% bars, magnified (x3.33) and 100% bars by pressing the vector GAIN key. The current setting is displayed on the front panel CAL and MAG lights. NTSC/525 does not have the 100% option and is set up for Beta Cam levels. The PAL SW key toggles the PAL switch defeat on and off.

### **DISPLAY ADJUSTMENTS**

#### **To change the displayed video**

To change the overall brightness, rotate the front panel BRIGHT control.

To change the graticule intensity, rotate the front panel SCALE control.

#### **To change the display persistence**

Pressing the front panel FRZ/STO key toggles between:

'Persistence ON', 'Persistence OFF and Freeze ON' and 'Both OFF'.

#### **To filter the displayed video waveform**

Pressing the front panel FILTER key switches between flat, low-pass and chroma pass filters.

The filter state is displayed on screen.

## REMOTE CONTROL

To remote control the unit via the RS232 interface: Data is sent on a 3 wire implementation of RS-232 ie Tx, Rx and Gnd. Data type is 8 bits, no parity, 1 stop bit. The baud rate is 9600. All commands consist of a single byte and are equivalent to pressing a key on the front panel.

### List of Key commands

Key	Byte value(decimal)
INPUT	115
FRZ/STO	179
WFM/VEC	211
EXT REF	227
GAMUT	64
H RANGE	112
PARADE	176
V RANGE	208
LINE SEL	224
FILTER	113
BOWTIE	177
CAL	209
GAIN(VID)	225
PAL SW	114
AUD	178
STO/RCL	210
GAIN(VEC)	226

### List of Rotary commands

Key	Byte value (decimal)
HORIZONTAL SHIFT CONTROL MOVES 1 STEP CW	1
HORIZONTAL SHIFT CONTROL MOVES 1 STEP ACW	2
VERTICAL SHIFT CONTROL MOVES 1 STEP CW	3
VERTICAL SHIFT CONTROL MOVES 1 STEP ACW	4
PHASE SHIFT CONTROL MOVES 1 STEP CW	5
PHASE SHIFT CONTROL MOVES 1 STEP ACW	6
SCALE CONTROL MOVES 1 STEP CW	7
SCALE CONTROL MOVES 1 STEP ACW	8
BRIGHT CONTROL MOVES 1 STEP CW	9
BRIGHT CONTROL MOVES 1 STEP ACW	10

## ADDITIONAL FUNCTIONS

### To start the unit in a known state

Powering on the unit normally will recall the settings previously used, but if previous settings were non standard, factory set mode can be established to allow faster use.

With the power switched off, press the front panel INPUT button whilst powering up the unit. It will then be in the following mode:

INPUT:	CST	AUD:	OFF
TIMEBASE:	H	CAL:	OFF
REF	INT	AUDIO SCALE:	PPM
FREEZE:	OFF	FILTER:	FLAT
PERSIST:	OFF	BOWTIE:	OFF
WFM GAIN:	X1	PARADE:	OFF
VECTOR GAIN:	100%	VID:	ON
PAL SWITCH:	OFF	VEC:	ON

### To store and recall user settings

When the unit is switched off the current setting are stored and then recalled when the unit is switched on again. In addition, ten sets of front panel setting can be stored for later recall.

To Store Settings:

When the unit is set up as required press the front panel STR/REC key twice, then press a key 0...9 to store the settings at that location.

To Recall the settings:

Press the front panel STO/REC key once, followed by the required location number 0...9.

### Power Source

The LCDSCOPE can be powered from the supplied adaptor, providing 12V @1 amp regulated, or from the internal 1.5Ahr NiMh rechargeable batteries.

Set the rear POWER switch to the upper INT position to use the internal batteries or to the lower EXT position to use external power.

### Battery Charging

When external power is supplied, and the POWER switch is in the lower EXT position, the batteries are automatically charged, whether or not the unit is switched on.

## AUDIO OPTION

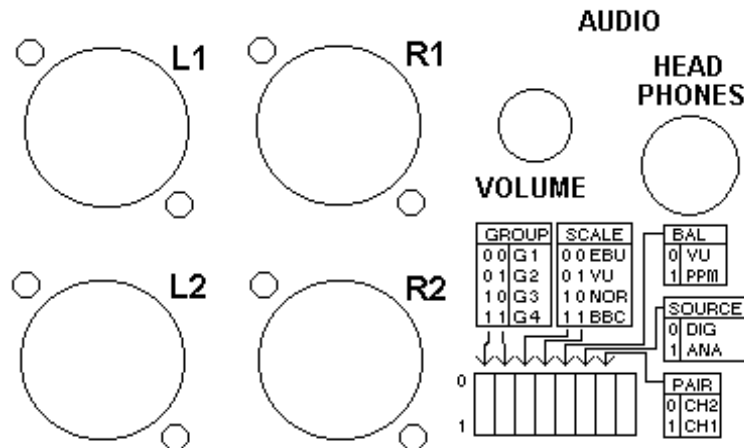

Fig 6

### To select the audio source

The displayed audio is taken from the rear xlr connectors, except when digital video is selected, when it is de-embedded from the video. A rear panel dip switch selects one of the four audio groups.

### To select audio scales

A rear panel dip switch selects one of four audio scales:

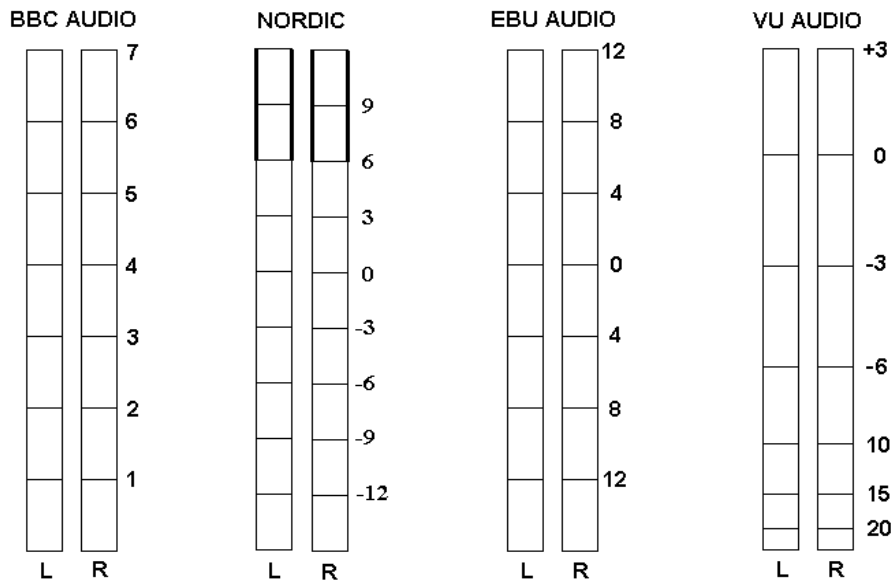

Fig 7

### Audio Vectors

Press the front panel AUD key to switch between video and audio vector display.

### Audio output

A professional jack socket is provided on the rear panel, together with a volume control, to monitor the displayed audio signal.

## CALIBRATION

The unit is calibrated and tested before leaving the factory and should not normally need to be changed.

If calibration or testing is required:

On the front panel board - Set CV101 master clock frequency for 2.0V at R110

On the main bottom board - Set RV401 for 700mV waveform cal signal  
Set RV407 for 100% vector cal circle  
Set CV401 for flat waveform response in HD mode.  
Set RV409 for waveform Cal gain  
Set RV408 for waveform Mag gain  
Set RV403 for centre null on bowtie display  
Set L402 for minimum chroma on Low Pass display  
Set L403 for highest chroma Pass display  
Set RV404,405,406 for balanced gamut RGB display  
Set RV410 for vertical position of gamut display

On the Audio board - Set RV301,302,303,304 for audio bar calibration  
Set RV305 for bar bottom position  
Set RV306,307 for audio vector centering

Set RV312,313 for overall vector gain  
Set RV311 for vector horizontal centering  
Set L301 for straight lines between the vector dots  
Set RV309 for composite vector gain  
Set RV310 for composite vector width  
Set CV301 for PAL vector lock  
Set CV302 for NTSC vector lock  
Set RV314 for minimum vector jitter  
Set L302 for PAL 90 degree  
Set CV303 for NTSC 90 degree

On the Digital board - Set RV501,502,503 for 700mV Y,Cb,Cr levels in SD mode.  
Set RV504,505,506 for 700mV Y,Cb,Cr levels in HD mode.  
Set RV507 for pedestal cancel in HD mode.

## TECHNICAL SPECIFICATION

### INPUTS

- Composite input. BNC connector with loop through output. Return loss better than 40dB. Zin of 22k. Max dc +/- 3 volts.
- YC input. 4 pin mini din socket with loop through output. Return loss better than 40dB. Zin of 22k. Max dc +/- 3 volts.
- Component input. 3 x BNC connectors with switchable terms. Return loss better than 40dB. Zin of 75R or 22k. Max dc +/- 3 volts. YCrCb or RGB.
- SD/HD digital input. BNC connector. Input impedance 75 ohms. Max d.c. +/- 10V.  
SMPTE 259M serial digital at 800mV p/p.  
SMPTE 292M high definition serial digital at 800mV p/p.  
Auto equalised up to 350 metres of cable at 270mb/s.  
Auto equalised up to 140 metres of cable at 1.485Gb/s.
- SD/HD digital output. BNC connector. Output impedance 75 ohms. Equalised version of the serial digital input.
- External ref input. BNC connector with loop through output. Return loss better than 40dB. Zin of 22k. Max dc +/- 3 volts.

### AUDIO

4 x Analog balanced inputs. Zin 22K.

### AUDIO MONITORING OUTPUT

Quarter inch professional stereo jack.

### VIDEO OUTPUT

Y,Cr,Cb and sync component output from the SD or HD serial digital video.

Y bandwidth 30MHz in HD or 5.5MHz in SD.

Cr,Cb bandwidth 15MHz in HD or 2.7MHz in SD.

Breakout cable supplied to four bnc sockets.

### REMOTE CONTROL

9 pin D socket for GPI, data up/down load and remote control. RS232 bits, no parity, 1 stop bit. The baud rate is 9600.

**Pin 1** GPI, closure to common.

**Pin 2** RS232 output.

**Pin3** RS232 input.

**Pin 4** Joined to pin 6.

**Pin 5** Ground.

**Pin 6** Joined to pin 4.

**Pin 7** Joined to pin 8.

**Pin 8** Joined to pin 7.

**Pin 9** n/c.

## TECHNICAL SPECIFICATION

### POWER

10 to 13V d.c. to 2.1mm jack. 1A max.

### ENVIRONMENT

Indoor use, 5 to 45 deg.C. ambient to 2,000m.

Max humidity 80% to 31 deg.C decreasing to 50% at 40 deg.C.

Overtoltage category 2. Pollution degree 1.

Weight 2.5Kg.

### DISPLAY AREAS

Display	100mm x 75.5mm viewing area.
Waveform	256 pixels wide x 240 pixels high.
Audio/Gamut area	Additional 64 pixels wide x 240 pixels high.

### WAVEFORM MONITOR

Response	Flat is +/- 1% 50Hz to 5.5MHz (25.0MHz in HD modes). Low Pass is -3db @ 1.5MHz, -60db @ 6.75MHz.
Timebase	H, 2H and Hmag (x5). V, 2V and Vmag. Line select is any line from the frame. Parade is a 3H display of input or filter parade.

### VECTOR MONITOR

Video	Traditional component or composite display. Component accuracy 0.2%. B/width 3.4MHz (12MHz in HD). Composite accuracy 1%. Bandwidth 1.3MHz .
Audio	Stereo phase display of left or right audio pair. Phase accuracy 2 deg.
Gamut	Poly™ display of RGB signal shows up illegal colours.

### AUDIO MONITOR

Accuracy	Better than 0.1db over full scale range.
Characteristics	BBC, EBU, Nordic and VU.

## TROUBLE SHOOTING

### **Unit appears dead:**

Check that the 12V supply adaptor is plugged into the unit and that this is plugged into an operational mains supply.

### **No display:**

Turn up the BRIGHT control (clockwise).

### **No video displayed:**

If there is no video signal connected to the selected input, the screen will display the graticules only:

### **Unusual display:**

The unit may be set to a non-standard mode. Press STO/REC and then one of the numbered buttons to recall a stored setting. If this does not cure the display, reset the unit as follows. Turn off, then turn on again whilst holding down the front panel INPUT key.

### **Displays not locked:**

May be in external reference mode. Press the front panel EXT REF key to cancel. This may need pressing twice to step through the HFT mode.

### **No vector display:**

Audio vectors may have been selected. Press the front panel AUD button to cancel.

### **Distorted component vector display:**

May be due to selection of the wrong input component format. Check the rear dip switch setting for RGB/YCrCb.

### **No audio bar graph display:**

May be in video gamut mode. Press the front panel GAMUT key to cancel.

### **Alarm sounding:**

This is the video gamut alarm. Hold down the front panel GAMUT key for one second. The letter A should disappear from the bottom right of the screen to show that the alarm is now disabled.

### **No Audio indication:**

Check that the rear dip switch setting corresponds with the audio input applied.

## ANALOG BASICS

### COMPONENT COLOUR

The colour picture can be distributed in two forms, whether in 625 or 525 line standards:

#### RGB

This is the basic signal produced by a camera etc and fed to a colour c.r.t. It consists of three primary signals, **Red**, **Green** and **Blue**. By convention, black level is at 0mV and peak brightness is at + 700mV.

#### YCrCb

As the human eye can see less resolution with colours, the video can be modified to take advantage of this to reduce the amount of information needed. The picture is separated into monochrome and colour components. The monochrome Y signal is formed from:

$Y = (0.3 \times \text{Red}) + (0.59 \times \text{Green}) + (0.11 \times \text{Blue})$  approximately.

This signal has black level at 0mV and maximum white level at + 700mV.

The colour components are two colour difference signals:

$Cr = (R - Y)$  and  $Cb = (B - Y)$

These are weighted to give maximum values of +/- 350mV and are bandwidth restricted to half that of the Y component.

**PAL** Fig 8 shows an encoded 100% colour bar signal. The two colour components of Cr and Cb are used to amplitude modulate a 4.43361875Mhz carrier signal. The two carriers are arranged to be 90 degrees apart before they are combined with the Y luminance signal, so that they can be decoded separately. The PAL system is designed to minimise hue errors by phase reversing the Cr axis on alternate lines (**Phase Alternate Line**). This reversal is copied by the decoder, so that the hue error will now alternate in phase. By combining the chrominance from two adjacent lines, the error is thus cancelled out.

#### NTSC

Fig 9 shows an encoded SMPTE (75%) colour bar signal. The two colour components of Cr and Cb are used to amplitude modulate a 3.579545Mhz carrier signal, but they are first modified into I and Q signals to reduce the overall maximum chrominance level when combined.

# PAL BASICS

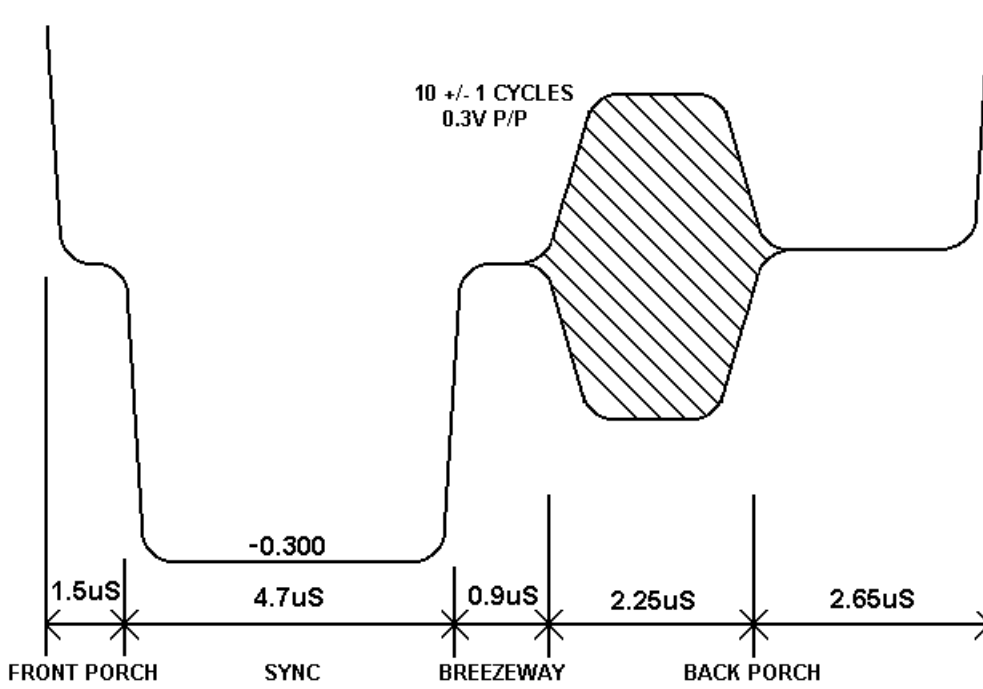
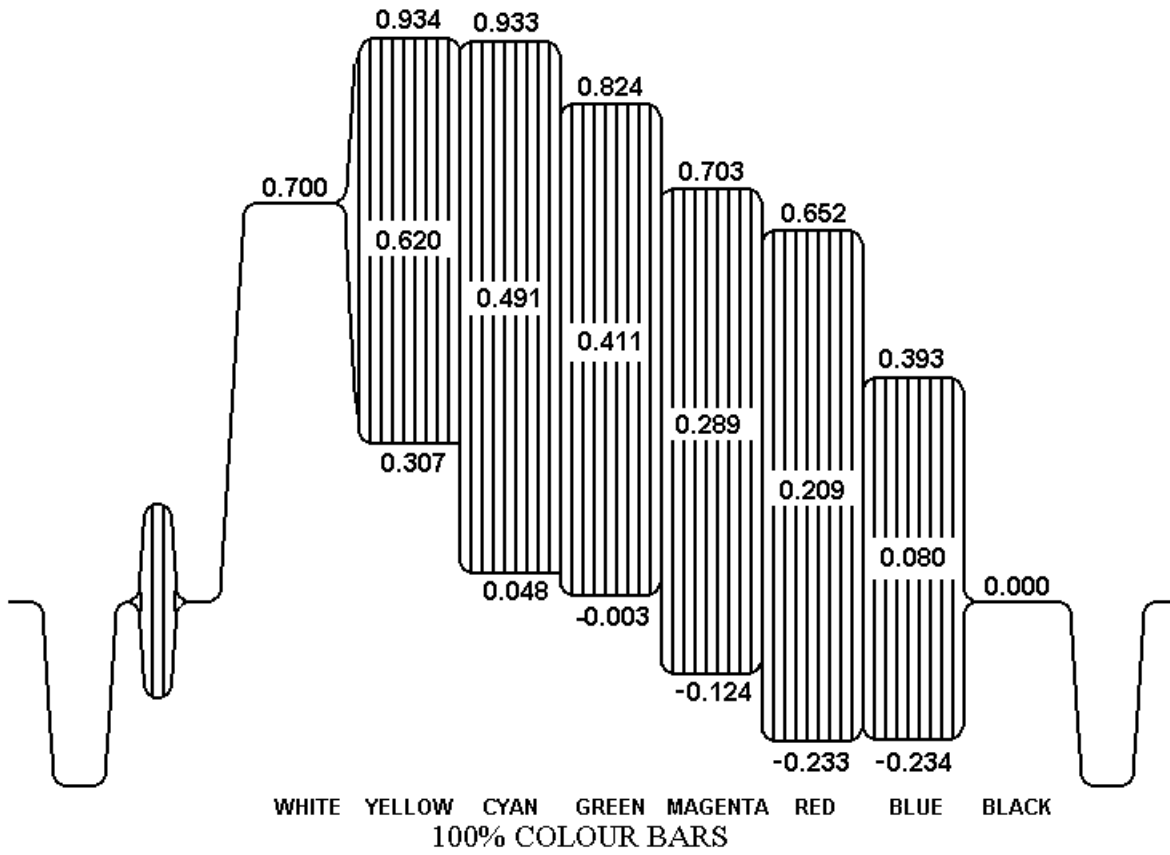

Fig 8

# NTSC BASICS

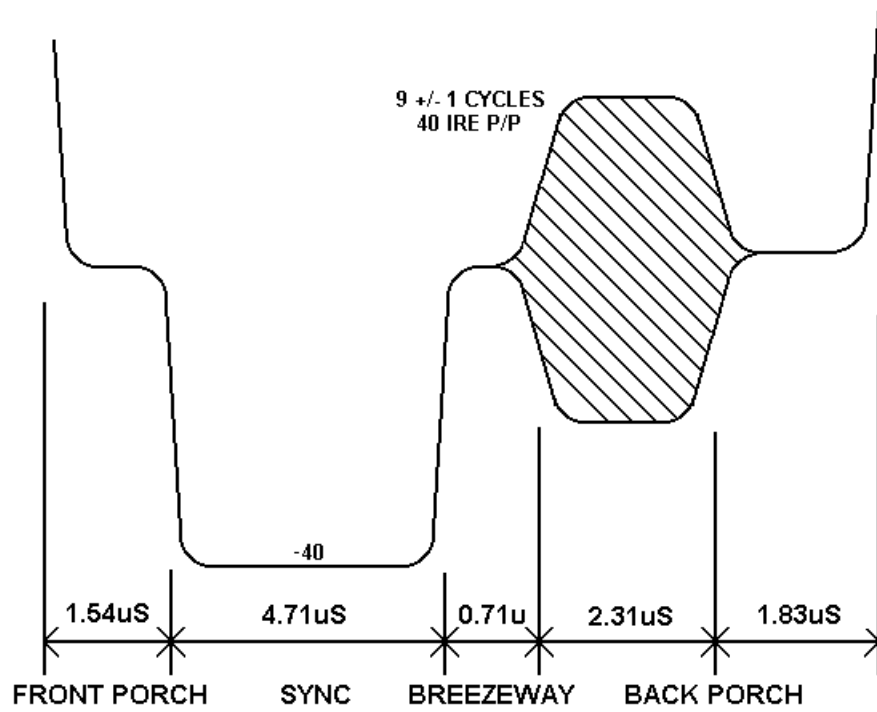
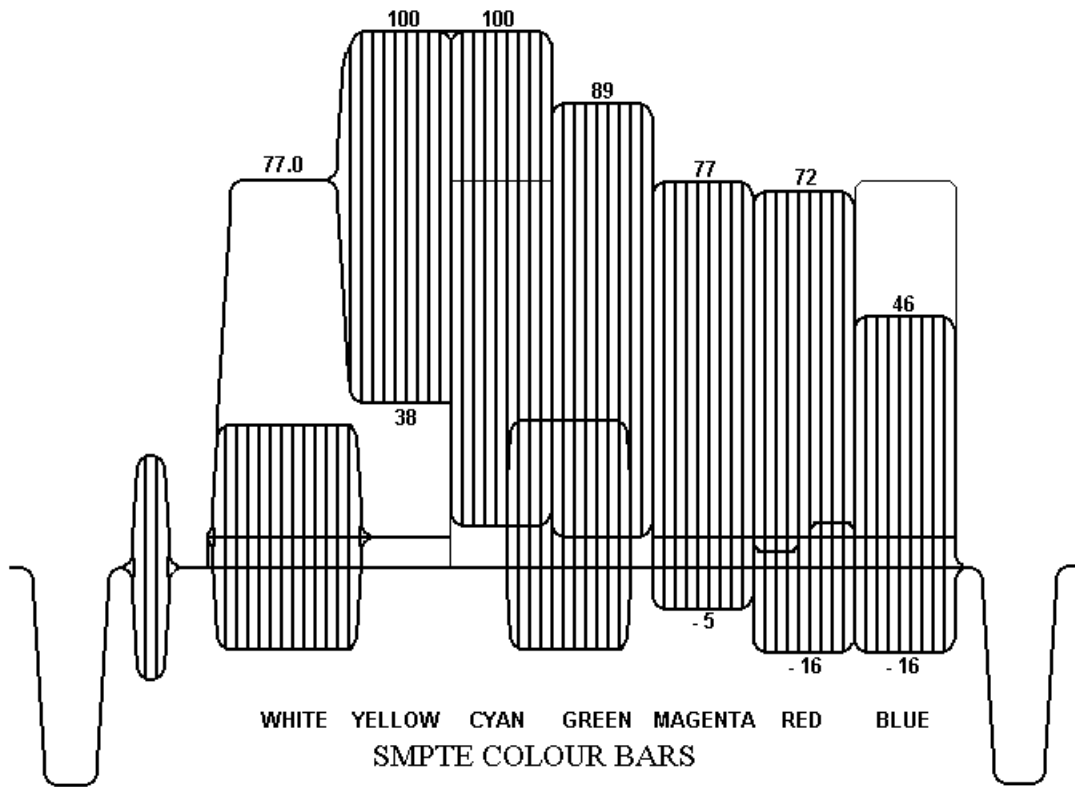

Fig 9

## SC-H RELATIONSHIP

PAL appears, at first sight, to be a four field system: field 1 being identical to field 5, and field 3 having the opposite pal switch phase. However, if a switch or edit is made between two video sources which are in the same pal sequence only, a small horizontal picture shift will often be noticed, this is due to the relationship between subcarrier and line frequencies. In order to avoid chroma patterning on monochrome receivers the PAL subcarrier frequency was chosen to have a 90 degree offset per television line, with 25Hz added on so that any remaining patterning would run through the picture:

$$F(\text{pal}) = (283.75 \times 15.625\text{KHz}) + 25\text{Hz} = 4.43361875\text{MHz}$$

The drawback of this is that after one PAL frame of four fields the subcarrier will have executed exactly 354689.50 cycles, so it will be 180 degrees shifted from its original phase at the same sync point. Hence the subcarrier to horizontal sync (SC-H) phase will only repeat every EIGHT fields.

A similar problem also exists in NTSC, except that it is a four field system rather than eight field.

$$F(\text{ntsc}) = (227.5 \times 15.73426373\text{KHz}) = 3.579545\text{MHz}$$

After one NTSC frame of two fields, the subcarrier will have executed exactly 119437.50 cycles, so it will then be exactly 180 degrees shifted from its original phase at the same sync point hence the sc-h phase will only repeat every FOUR fields.

If a video edit or switch is made without regard to the above field sequence, there is a 50/50 chance of picking the wrong eight field match. This will cause an SC-H phase jump producing a picture shift of half a cycle of subcarrier. Whilst this may be acceptable if cutting to a different shot, in animation or tag-editing the shift would be very noticeable.

To produce reliable match frame edits it is therefore necessary to identify the correct field sequence. In addition, if due to misalignment, the SC-H phase was displaced from the ideal by 90 degrees, the field relationship would be uncertain.

Both these problems can be addressed by having an instrument which displays the subcarrier phase to horizontal sync phasing. Zero SC-H phase has been defined as a positive zero-crossing of subcarrier at the vertical sync point on field 1.

Systems can now be adjusted in the exactly correct SC-H phase to avoid uncertainty when near to the 90 degree point. A video signal in the exactly wrong eight-field sequence would show up as an 180 degree SC-H phase error.

## SERIAL DIGITAL BASICS

625 and 525 digital component video is produced by applying a 4:2:2 sampling structure to the analog signal. This process is defined by a sub-set of international standards ITU-R BT.601 and BT.656. (these were formerly known as CCIR-601 and CCIR-656. The label 'CCIR601' is commonly applied to digital video coded in this manner.)

The luminance (Y) component is sampled at 13.5 MHz, and the colour difference components (U and V) are both sampled at 6.75 MHz. With 10 bit quantisation, this results in a data stream of 10 bit words at a clock frequency of 27 MHz. If the signal source uses 8 bit quantisation, 10 bit data is used with the two least significant bits of each sample code set to binary zero. This is to maintain the same data rate.

The quantizing levels employed in the analog to digital conversion are set to give 66.4mV headroom above peak white and 51.1mV below black. Coded U and V signals have 50mV above and below their normal maximum and minimum excursions.

The synchronisation pulses are discarded in the coding process, and are replaced by Timing Reference Signals (TRS) which are inserted into the data stream to serve the same purpose. Two TRS's are used to synchronise the data stream, EAV (End of Active Video) and SAV (Start of Active Video). These are placed at the beginning and end of the horizontal video blanking period. see fig 10.

Each TRS consists of 4 words:

- 1) 3ff hex ie all '1's
- 2) 000 hex ie all '0's
- 3) 000 hex ie all '0's
- 4) XYZ, which determines the type of TRS pulse:

XYZ:

Bit 9: always '1'

Bit 8: 0 = frame 1    1 = frame 2

Bit 7: 0 = normal    1 = field blanking

Bit 6: 0 = SAV    1 = EAV

Bit 5: Bits used for Hamming correction.

Bit 4: Bits used for Hamming correction.

Bit 3: Bits used for Hamming correction.

Bit 2: Bits used for Hamming correction.

Bit 1: Always '0'

Bit 0: Always '0'

## SERIAL DIGITAL BASICS

The period between EAV and SAV is not used by normal video and is available for other purposes eg: error checking, timecodes or embedded audio.

Illegal Values: The values 0 and 3FF hex are used solely by TRS pulses (EAV and SAV) they must not appear anywhere in the active video area.

Out of Gamut: Values apart from the illegal values which should not be used.

Luminance is defined as being between peak white, 700mV 3AC, hex and black, 0mV 040 hex.

Chroma is defined as being between max positive, 350mV 3C0, hex and max negative, -350mV 040 hex.

The values above and below these are termed out of gamut.

The data is serialised using an NRZ (None Return to Zero) code to produce a 270 Mb/s signal. This coding method removes any low frequency component and is insensitive to polarity. The data has to be scrambled first to avoid the possible transmission of all '0's. This data is output at 800mV p-p to normal 75 ohm video coaxial cable.

Due to the high frequencies, the cable losses are quite high, typically 10dB per 100 metres at 270 MHz. To allow acceptable cable lengths, automatic cable equalisers are used at the receiver which usually allow up to 300 metres of cable to be used. It is important that standard cable is used, otherwise the equaliser will not compensate correctly.

Suitable cable is: PSF 2/3 BELDEN 8281 F&G 1.0/6.6

### DIGITAL ERROR DETECTION OVERVIEW

In order to check if the digital video signal has been received correctly a Cyclic Redundancy Check (CRC) can be made on each frame in the generating equipment, this four digit number is then placed in a 'packet' and put in the EAV-SAV space of one line of each field.

At the receiving equipment the incoming video field also has a Cyclic Redundancy Check number calculated, this value is then compared with the 4 digit number sent in the packet. If the two numbers are not identical an error has occurred between transmission and reception of the signal.

## SERIAL DIGITAL BASICS

This type of error detection is known as Error Detection and Handling or EDH and is defined by SMPTE RP165. In practice two check sums are sent per frame, one for the active video period and one for the full frame. A typical packet consists of:

The Header: (000, 3FF, 3FF) This always precedes an EDH packet.

Data ID: (1F4)

Block Number: (200)

Data Count: This contains the number of words that follow.

Active picture crc: 3 words

Full-field crc: 3 words

Error flags: 3 words

Reserved: 7 words

Check Sum: This is used to test for transmission errors.

## EMBEDDED AUDIO OVERVIEW

The period between the EAV and SAV markers can be used to send embedded digital audio signals. This is known as SMPTE 272M. Up to 16 separate audio signals may be sent in a single video channel. These are organised as four GROUPS of four signals, the four signals are often two stereo pairs. Typically only one group will be used, giving two stereo pairs of audio. The audio data is digitised in the sending equipment to 20 bits of resolution, usually at a 48 KHz sample rate. Often only 16 bits are used in practice. The digitised data is arranged in packets which are placed in the EAV-SAV space.

A typical packet consists of:

The Header: (000, 3FF, 3FF) This always precedes an audio packet.

Data ID: This contains the Audio Group number.

Block Number: AES blocks have 192 'frames' of audio data

Data Count: This contains the number of words that follow.

Audio Sample:

Audio Sample:

Audio Sample:

Audio Sample:

Check Sum: This is used to test for transmission errors.

Each audio sample consists of a sample of all four audio signals,  
eg: Channel 1 left, Channel 1 right, Channel 2 left, Channel 2 right.

Each signal requires 3 words to hold all 20 bits data, thus each audio sample has 12 words in it. Typically 3 or 4 audio samples are sent in each EAV-SAV period.

As with the video signal, words which consist of all '1's or all '0's are not allowed.

## SERIAL DIGITAL BASICS

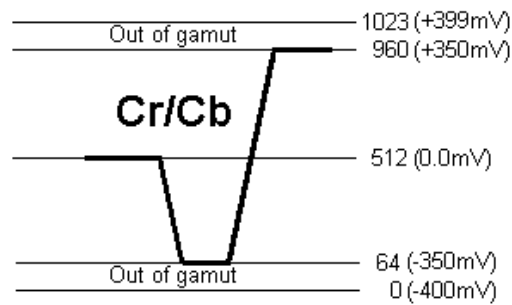
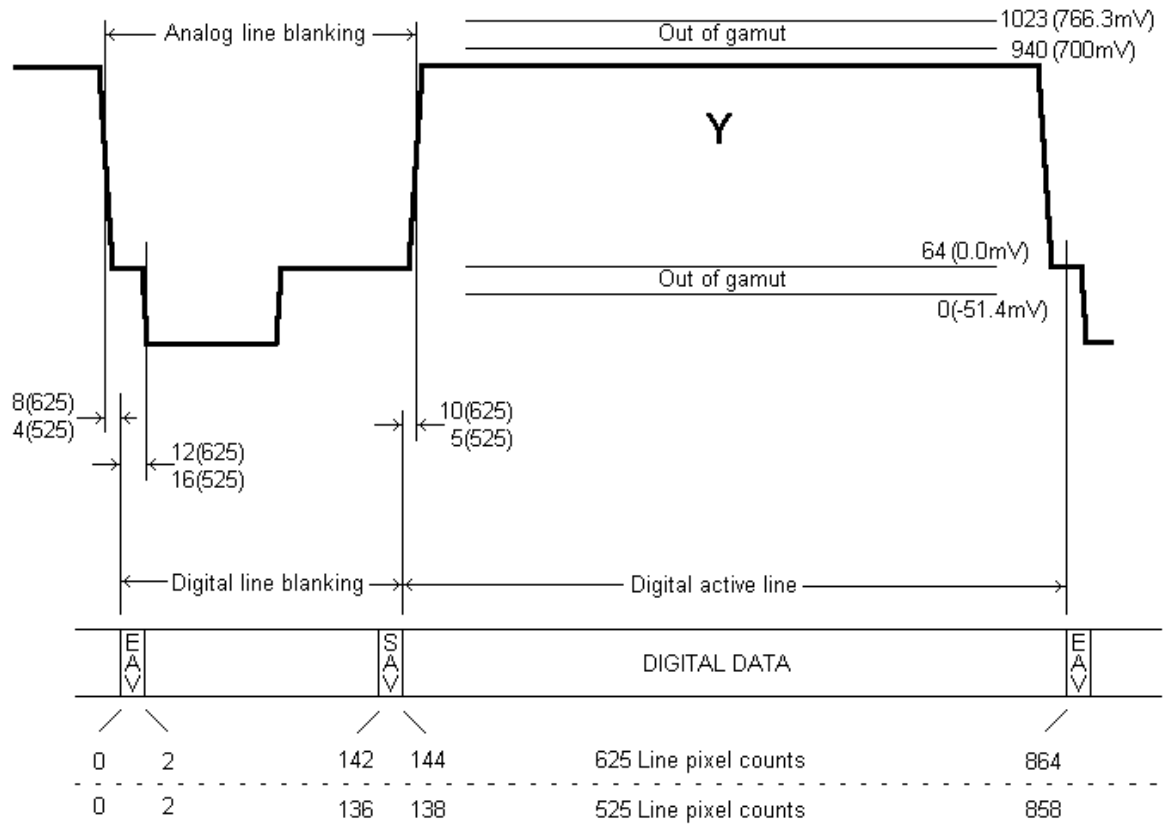
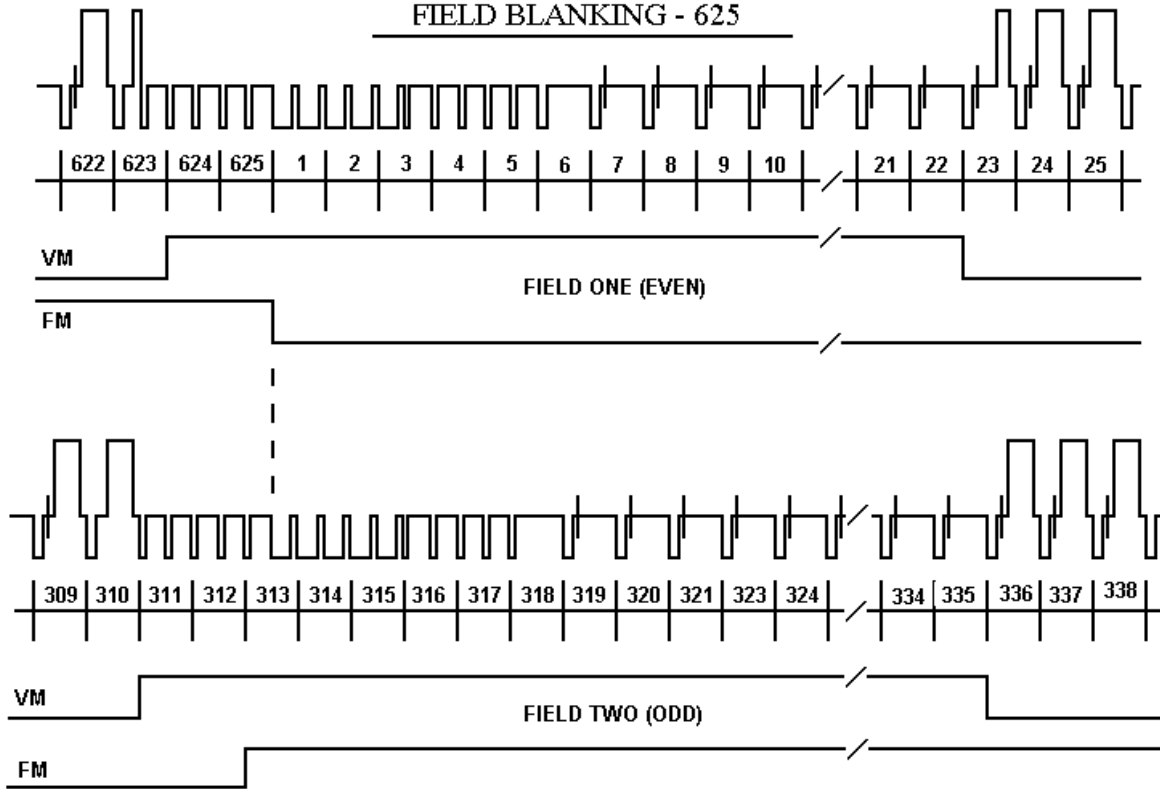

Fig 10

## SERIAL DIGITAL BASICS

### FIELD BLANKING - 625



### FIELD BLANKING - 525

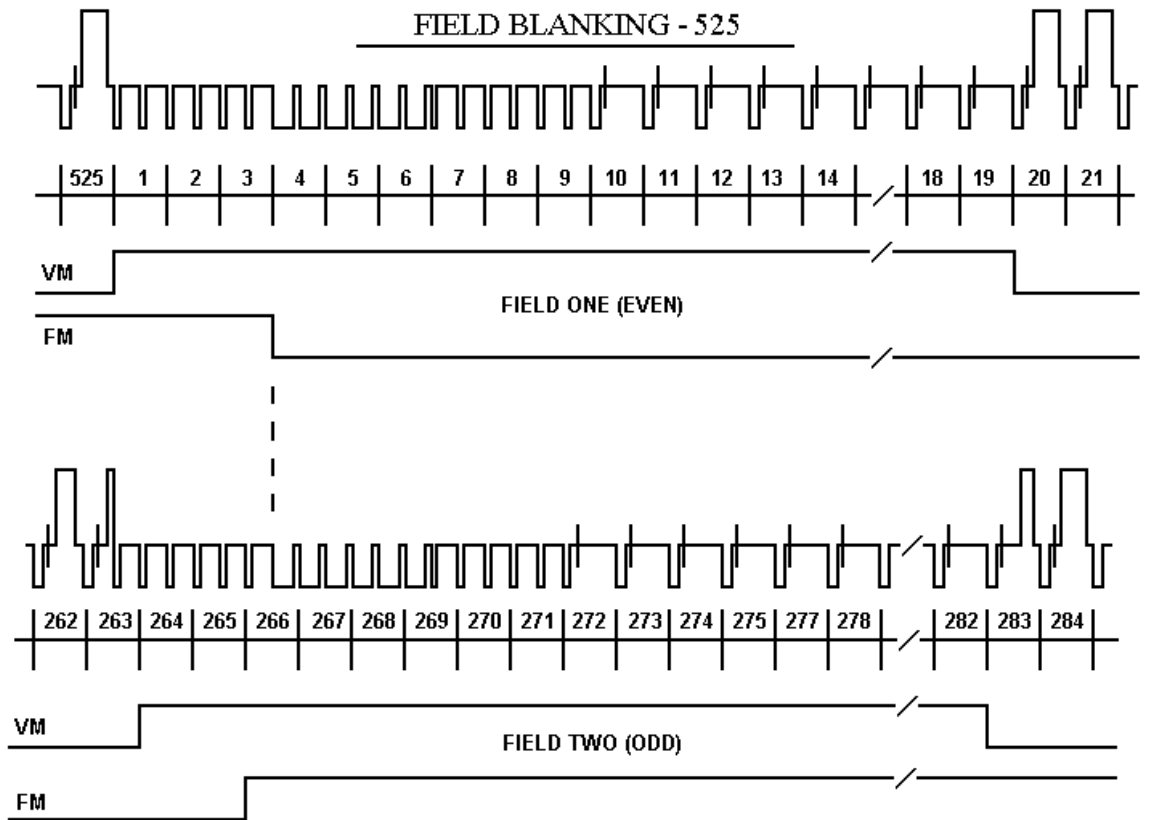

Fig 11/12

## HDTV SERIAL DIGITAL BASICS

### BIT SERIAL DIGITAL INTERFACE DEFINED BY SMPTE 292M.

HDTV digital component video is produced by applying a 4:2:2 sampling structure to the analog signal. The luminance component (Y) is sampled at 74.25 MHz, the colour difference components U & V) are both sampled at 37.125 MHz.

The Y stream is quantised to 10 bits resolution and Timing Reference Signals (TRS) are added at the beginning and end of the horizontal video blanking period.

The U & V streams are also quantised to 10 bits and then interleaved to give a C stream at 74.25 MHz. TRS are added at the beginning and end of the horizontal video blanking period.

The 74.25MHz Y and C streams are then interleaved to produce a single stream at 148.5MHz.

This data is then scrambled and serialised using a None Return to Zero (NRZ) code to produce a 1.485 GHz signal.

The TRS at the end of the horizontal blanking period is called Start of Active Video (SAV) it consists of 4 words:

- 1) 3FF hex ie all '1's
- 2) 000 hex ie all '0's
- 3) 000 hex ie all '0's
- 4) XYZ, which determines the type of TRS pulse, consisting of:

Bit 9: Always '1'

Bit 8: 0=frame 1, 1=frame 2

Bit 7: 0=normal 1=field blanking

Bit 6: 0=SAV 1=EAV

Bit 5: Bits used for Hamming correction.

Bit 4: Bits used for Hamming correction.

Bit 3: Bits used for Hamming correction.

Bit 2: Bits used for Hamming correction.

Bit 1: Always 0

Bit 0: Always 0

The TRS at the beginning of the horizontal blanking period is called End of Active Video (EAV) it consists of 8 words: The first 4 are the same as for SAV, followed by 2 words containing the current line number and 2 words containing a Cyclic Redundancy Check (CRC) for all the preceding words in the line. The period between EAV and SAV is not used by normal video and may be used for embedded audio or timecode data.

### ILLEGAL VALUES

The values 000 and 3FF hex are used solely by TRS pulses (EAV & SAV) they must not appear anywhere in the active video area.

## SAMPLE STRUCTURE

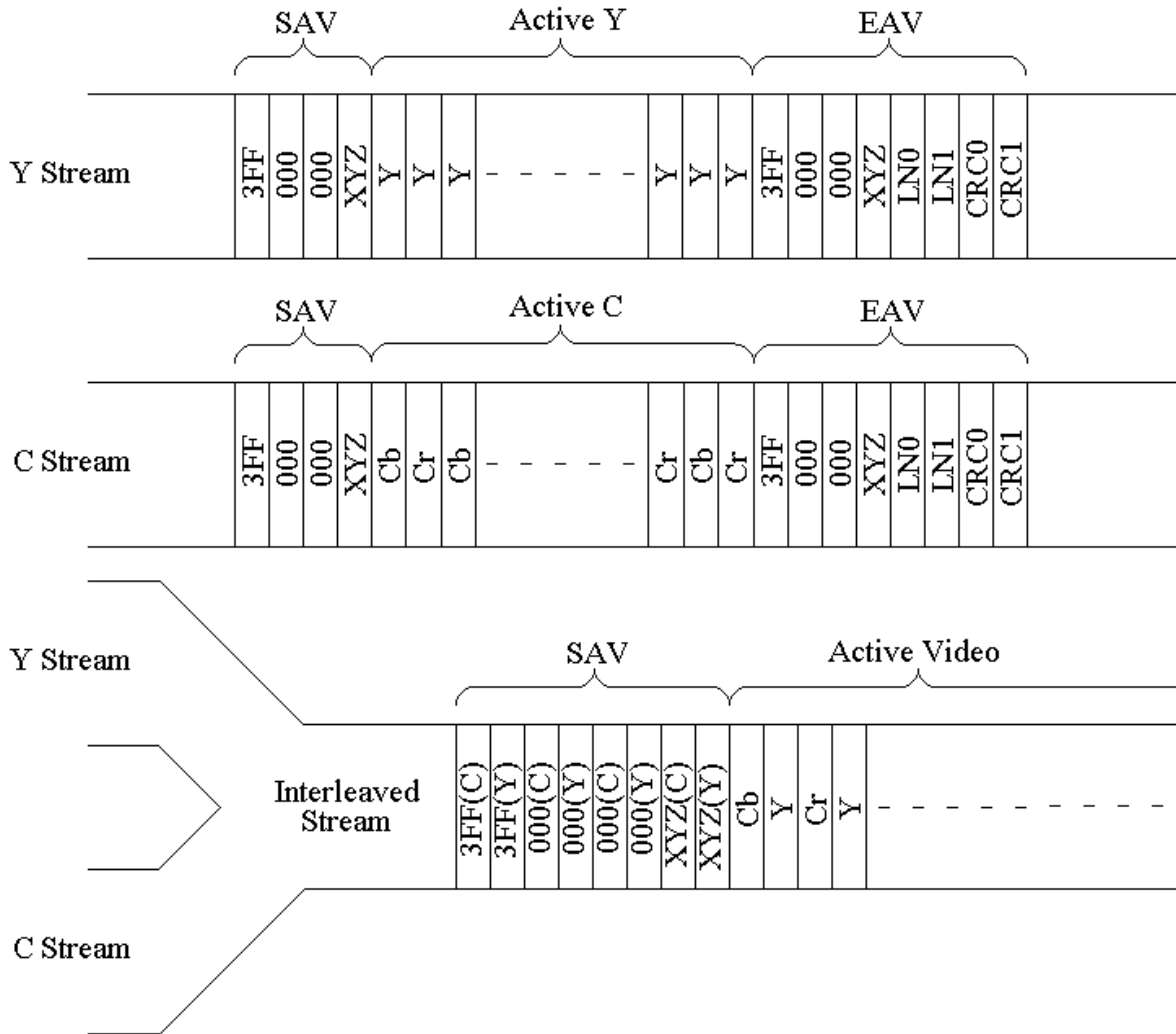

Fig 13

## PARALLEL DIGITAL INTERFACES

Several parallel video Standards can be used with the above serial interface. These are defined in SMPTE 274M for 1920 x 1080 scanning and SMPTE 296M for 1280 x 720 scanning.

### **SMPTE 274M**

Several sub-standards for this are defined:

#### 1920 x 1080/60/2:1

1920 samples/active line 1080 active line/frame 30PsF segmented format.  
74.25 MHz Sample frequency 2200 total samples/line 1125 total lines/frame

#### 1920 x 1080/59.94/2:1

1920 samples/active line 1080 active line/frame 29.97PsF segmented format.  
74.176 MHz Sample frequency 2200 total samples/line 1125 total lines/frame  
This standard gives an exact frame rate compatibility with NTSC.

#### 1920 x 1080/50/2:1

1920 samples/active line 1080 active line/frame 25PsF segmented format.  
74.25 MHz Sample frequency 2640 total samples/line 1125 total lines/frame

#### 1920 x 1080/30/1:1

1920 samples/active line 1080 active line/frame 30 Hz Progressive scan.  
74.25 MHz Sample frequency 2200 total samples/line 1125 total lines/frame

#### 1920 x 1080/29.97/1:1

1920 samples/active line 1080 active line/frame 29.97 Hz Progressive scan.  
74.176 MHz Sample frequency 2200 total samples/line 1125 total lines/frame  
This standard gives an exact frame rate compatibility with NTSC.

#### 1920 x 1080/25/1:1

1920 samples/active line 1080 active line/frame 25 Hz Progressive scan.  
74.25 MHz Sample frequency 2640 total samples/line 1125 total lines/frame

#### 1920 x 1080/24/1:1

1920 samples/active line 1080 active line/frame 24 Hz Progressive scan.  
74.25 MHz Sample frequency 2750 total samples/line 1125 total lines/frame

#### 1920 x 1080/24sf

1920 samples/active line 1080 activelines/frame 24 Hz segmented frame  
74.25 MHz sample frequency 2750 total samples/line 1125 total lines/frame

#### 1920 x 1080/23.98/1:1

1920 samples/active line 1080 active line/frame 23.98 Hz Progressive scan.  
74.176 MHz Sample frequency 2750 total samples/line 1125 total lines/frame



## HDTV SERIAL DIGITAL BASICS

The Header: (000, 3FF, 3FF)

Data ID: This contains the Audio group number.

Data block number: AES frames have 192 samples of audio data

Data Count: This contains the number of words that follow, always 218 hex

Clock: 2 words containing the number of video clocks that have elapsed between the first word of EAV and the time the audio sample was made, it is used by the receiving equipment to reconstruct the audio signal with the correct phase delay.

Audio Sample 1: Consists of four words

Audio Sample 2: Consists of four words

Audio Sample 3: Consists of four words

Audio Sample 4: Consists of four words

### Error Correction Codes

Consist of six words used by the receiving equipment to detect or correct errors in the 24 words from the header to the last word of audio sample 4 inclusive.

Check Sum This is the sum of all previous words in the packet except the header words.

Each audio packet contains a sample of all four audio signals

eg: Channel 1 left, Channel 1 right, Channel 2 left and Channel 2 right.

Each audio signal requires 3 words to hold all 24 bits, thus each audio packet has 12 words of audio data.

Typically one or two packets are sent in each EAV-SAV period.

These audio data packets are placed in the Chroma data stream only.

### Audio Control Packets.

The audio control packet structure is similar to the audio data packet.

Data in the packet includes the audio sample rate eg 48 KHz,

the number of active channels out of the possible 4,

the delay information between Channel 1 audio and Channel 2

and delay information between Channel 3 audio and Channel 4.

Audio control packets are placed in the Luminance Stream, this is sent once per frame in the second line after the switching point.

As with the video signal words consisting of all '1's or all '0's are not allowed.

## USEFUL WEBSITES

HAMLET	<a href="http://www.hamlet.co.uk">www.hamlet.co.uk</a>	
HAMLET (USA)	<a href="http://www.hamlet.us.com">www.hamlet.us.com</a>	
SMPTE	<a href="http://www.smpte.org">www.smpte.org</a>	Society of Motion Picture Television Engineers
DIN	<a href="http://www.din.de">www.din.de</a>	German Standards Institute
EBU	<a href="http://www.ebu.ch">www.ebu.ch</a>	European Broadcasting Union
AES	<a href="http://www.aes.org">www.aes.org</a>	Audio Engineering Society
ITU	<a href="http://www.itu.int">www.itu.int</a>	International Telecommunication Union

## CONTACT DETAILS AND CUSTOMER SUPPORT

For any form of assistance in maintaining your LCDSCOPE, please contact:

Hamlet Video International Limited.  
Maple House, 11 Corinium Business Centre, Raans Road, Amersham, Bucks HP6 6FB  
England.  
Main Line: +44 (0)1494 729 728  
Fax Line: +44 (0)1494 723 237  
Free phone (UK): 0500 625 525  
E-mail: [sales@hamlet.co.uk](mailto:sales@hamlet.co.uk) Web site: [www.hamlet.co.uk](http://www.hamlet.co.uk)

Hamlet Video International USA service center , Tecads Inc, 23 Del Padre St, Foothill  
Ranch, CA 92610, U.S.A.  
Tel: +1 (949) 597 1053  
Fax: +1 (949) 597 1094  
Toll Free Tel number: (866) 4 HAMLET  
E-mail: [service@hamlet.us.com](mailto:service@hamlet.us.com) Web site: [www.hamlet.us.com](http://www.hamlet.us.com)

In correspondence concerning this instrument, please quote the serial number, which you will find printed on the label at the back of the unit.